

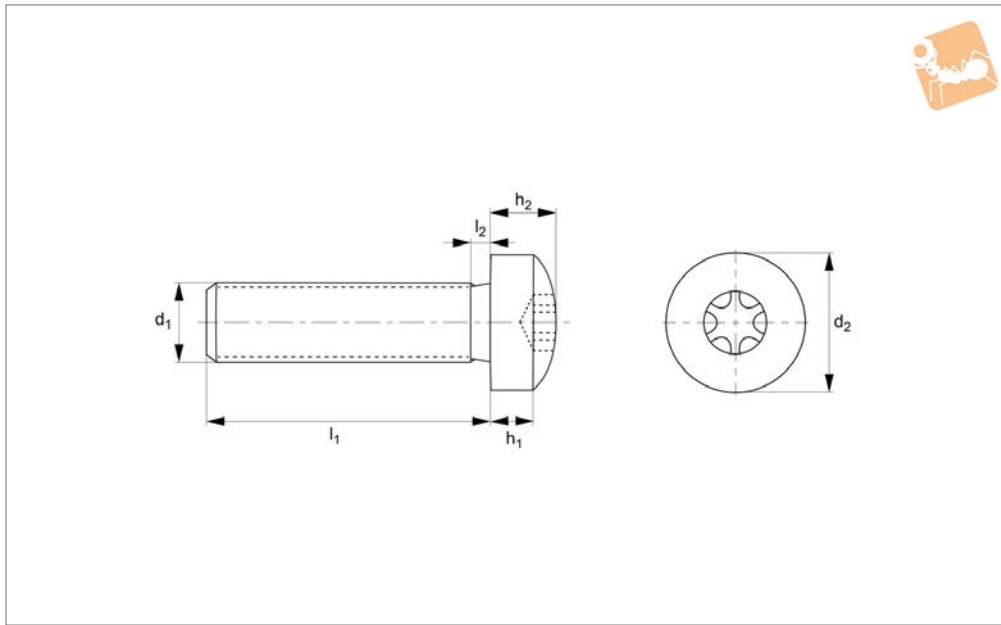

TX Pan Head Screws

TX - A4 stainless

Standard Screws



P0236.A4

STANDARD SCREWS

Material
Stainless steel (A4).

2,5 x pitch of head.

Technical Notes
To DIN 7985, ISO 7045. Threaded within

See technical page for tightening torques.

Order No.	d ₁	l ₁	d ₂	h ₁	Size	h ₂	l ₂
P0236.016-003-A4	M1,6	3	3.2	1.3	TX-5	0.8	0.7
P0236.016-004-A4	M1,6	4	3.2	1.3	TX-5	0.8	0.7
P0236.016-005-A4	M1,6	5	3.2	1.3	TX-5	0.8	0.7
P0236.016-006-A4	M1,6	6	3.2	1.3	TX-5	0.8	0.7
P0236.016-008-A4	M1,6	8	3.2	1.3	TX-5	0.8	0.7
P0236.016-010-A4	M1,6	10	3.2	1.3	TX-5	0.8	0.7
P0236.016-012-A4	M1,6	12	3.2	1.3	TX-5	0.8	0.7
P0236.016-014-A4	M1,6	14	3.2	1.3	TX-5	0.8	0.7
P0236.016-016-A4	M1,6	16	3.2	1.3	TX-5	0.8	0.7
P0236.016-018-A4	M1,6	18	3.2	1.3	TX-5	0.8	0.7
P0236.020-003-A4	M 2	3	4.0	1.6	TX-6	1.1	0.8
P0236.020-004-A4	M 2	4	4.0	1.6	TX-6	1.1	0.8
P0236.020-005-A4	M 2	5	4.0	1.6	TX-6	1.1	0.8
P0236.020-006-A4	M 2	6	4.0	1.6	TX-6	1.1	0.8
P0236.020-008-A4	M 2	8	4.0	1.6	TX-6	1.1	0.8
P0236.020-010-A4	M 2	10	4.0	1.6	TX-6	1.1	0.8
P0236.020-012-A4	M 2	12	4.0	1.6	TX-6	1.1	0.8
P0236.020-014-A4	M 2	14	4.0	1.6	TX-6	1.1	0.8
P0236.020-016-A4	M 2	16	4.0	1.6	TX-6	1.1	0.8
P0236.020-018-A4	M 2	18	4.0	1.6	TX-6	1.1	0.8
P0236.020-020-A4	M 2	20	4.0	1.6	TX-6	1.1	0.8
P0236.025-003-A4	M2,5	3	5.0	2.0	TX-8	1.3	0.9
P0236.025-004-A4	M2,5	4	5.0	2.0	TX-8	1.3	0.9
P0236.025-005-A4	M2,5	5	5.0	2.0	TX-8	1.3	0.9
P0236.025-006-A4	M2,5	6	5.0	2.0	TX-8	1.3	0.9
P0236.025-008-A4	M2,5	8	5.0	2.0	TX-8	1.3	0.9
P0236.025-010-A4	M2,5	10	5.0	2.0	TX-8	1.3	0.9
P0236.025-012-A4	M2,5	12	5.0	2.0	TX-8	1.3	0.9
P0236.025-014-A4	M2,5	14	5.0	2.0	TX-8	1.3	0.9
P0236.025-016-A4	M2,5	16	5.0	2.0	TX-8	1.3	0.9
P0236.025-018-A4	M2,5	18	5.0	2.0	TX-8	1.3	0.9
P0236.025-020-A4	M2,5	20	5.0	2.0	TX-8	1.3	0.9
P0236.025-022-A4	M2,5	22	5.0	2.0	TX-8	1.3	0.9
P0236.025-025-A4	M2,5	25	5.0	2.0	TX-8	1.3	0.9



STANDARD SCREWS

Order No.	d ₁	l ₁	d ₂	h ₁	Size	h ₂	l ₂
P0236.025-028-A4	M2,5	28	5.0	2.0	TX-8	1.3	0.9
P0236.025-030-A4	M2,5	30	5.0	2.0	TX-8	1.3	0.9
P0236.030-004-A4	M 3	4	6.0	2.4	TX-10	1.6	1.0
P0236.030-005-A4	M 3	5	6.0	2.4	TX-10	1.6	1.0
P0236.030-006-A4	M 3	6	6.0	2.4	TX-10	1.6	1.0
P0236.030-008-A4	M 3	8	6.0	2.4	TX-10	1.6	1.0
P0236.030-010-A4	M 3	10	6.0	2.4	TX-10	1.6	1.0
P0236.030-012-A4	M 3	12	6.0	2.4	TX-10	1.6	1.0
P0236.030-014-A4	M 3	14	6.0	2.4	TX-10	1.6	1.0
P0236.030-016-A4	M 3	16	6.0	2.4	TX-10	1.6	1.0
P0236.030-018-A4	M 3	18	6.0	2.4	TX-10	1.6	1.0
P0236.030-020-A4	M 3	20	6.0	2.4	TX-10	1.6	1.0
P0236.030-022-A4	M 3	22	6.0	2.4	TX-10	1.6	1.0
P0236.030-025-A4	M 3	25	6.0	2.4	TX-10	1.6	1.0
P0236.030-028-A4	M 3	28	6.0	2.4	TX-10	1.6	1.0
P0236.030-030-A4	M 3	30	6.0	2.4	TX-10	1.6	1.0
P0236.030-035-A4	M 3	35	6.0	2.4	TX-10	1.6	1.0
P0236.030-040-A4	M 3	40	6.0	2.4	TX-10	1.6	1.0
P0236.030-045-A4	M 3	45	6.0	2.4	TX-10	1.6	1.0
P0236.030-050-A4	M 3	50	6.0	2.4	TX-10	1.6	1.0
P0236.030-055-A4	M 3	55	6.0	2.4	TX-10	1.6	1.0
P0236.030-060-A4	M 3	60	6.0	2.4	TX-10	1.6	1.0
P0236.040-004-A4	M 4	4	8.0	3.1	TX-20	2.0	1.4
P0236.040-005-A4	M 4	5	8.0	3.1	TX-20	2.0	1.4
P0236.040-006-A4	M 4	6	8.0	3.1	TX-20	2.0	1.4
P0236.040-008-A4	M 4	8	8.0	3.1	TX-20	2.0	1.4
P0236.040-010-A4	M 4	10	8.0	3.1	TX-20	2.0	1.4
P0236.040-012-A4	M 4	12	8.0	3.1	TX-20	2.0	1.4
P0236.040-014-A4	M 4	14	8.0	3.1	TX-20	2.0	1.4
P0236.040-016-A4	M 4	16	8.0	3.1	TX-20	2.0	1.4
P0236.040-018-A4	M 4	18	8.0	3.1	TX-20	2.0	1.4
P0236.040-020-A4	M 4	20	8.0	3.1	TX-20	2.0	1.4
P0236.040-022-A4	M 4	22	8.0	3.1	TX-20	2.0	1.4
P0236.040-025-A4	M4	25	8.0	3.1	TX-20	2.0	1.4
P0236.040-028-A4	M 4	28	8.0	3.1	TX-20	2.0	1.4
P0236.040-030-A4	M 4	30	8.0	3.1	TX-20	2.0	1.4
P0236.040-035-A4	M 4	35	8.0	3.1	TX-20	2.0	1.4
P0236.040-040-A4	M 4	40	8.0	3.1	TX-20	2.0	1.4
P0236.040-045-A4	M 4	45	8.0	3.1	TX-20	2.0	1.4
P0236.040-050-A4	M 4	50	8.0	3.1	TX-20	2.0	1.4
P0236.040-055-A4	M 4	55	8.0	3.1	TX-20	2.0	1.4
P0236.040-060-A4	M 4	60	8.0	3.1	TX-20	2.0	1.4
P0236.040-065-A4	M 4	65	8.0	3.1	TX-20	2.0	1.4
P0236.040-070-A4	M 4	70	8.0	3.1	TX-20	2.0	1.4
P0236.040-075-A4	M 4	75	8.0	3.1	TX-20	2.0	1.4
P0236.040-080-A4	M 4	80	8.0	3.1	TX-20	2.0	1.4
P0236.040-090-A4	M 4	90	8.0	3.1	TX-20	2.0	1.4
P0236.040-100-A4	M 4	100	8.0	3.1	TX-20	2.0	1.4
P0236.050-006-A4	M 5	6	10.0	3.8	TX-25	2.5	1.6
P0236.050-008-A4	M 5	8	10.0	3.8	TX-25	2.5	1.6
P0236.050-012-A4	M 5	12	10.0	3.8	TX-25	2.5	1.6
P0236.050-014-A4	M 5	14	10.0	3.8	TX-25	2.5	1.6
P0236.050-016-A4	M 5	16	10.0	3.8	TX-25	2.5	1.6
P0236.050-018-A4	M 5	18	10.0	3.8	TX-25	2.5	1.6
P0236.050-020-A4	M 5	20	10.0	3.8	TX-25	2.5	1.6
P0236.050-022-A4	M 5	22	10.0	3.8	TX-25	2.5	1.6
P0236.050-025-A4	M 5	25	10.0	3.8	TX-25	2.5	1.6
P0236.050-028-A4	M 5	28	10.0	3.8	TX-25	2.5	1.6
P0236.050-030-A4	M 5	30	10.0	3.8	TX-25	2.5	1.6
P0236.050-035-A4	M 5	35	10.0	3.8	TX-25	2.5	1.6
P0236.050-040-A4	M 5	40	10.0	3.8	TX-25	2.5	1.6
P0236.050-045-A4	M 5	45	10.0	3.8	TX-25	2.5	1.6
P0236.050-050-A4	M 5	50	10.0	3.8	TX-25	2.5	1.6
P0236.050-055-A4	M 5	55	10.0	3.8	TX-25	2.5	1.6
P0236.050-060-A4	M 5	60	10.0	3.8	TX-25	2.5	1.6
P0236.050-065-A4	M 5	65	10.0	3.8	TX-25	2.5	1.6
P0236.050-070-A4	M 5	70	10.0	3.8	TX-25	2.5	1.6
P0236.050-075-A4	M 5	75	10.0	3.8	TX-25	2.5	1.6
P0236.050-080-A4	M 5	80	10.0	3.8	TX-25	2.5	1.6



TX Pan Head Screws

TX - A4 stainless

Standard Screws



Order No.	d ₁	l ₁	d ₂	h ₁	Size	h ₂	l ₂
P0236.050-090-A4	M 5	90	10.0	3.8	TX-25	2.5	1.6
P0236.050-100-A4	M 5	100	10.0	3.8	TX-25	2.5	1.6
P0236.060-008-A4	M 6	8	12.0	4.6	TX-30	3.0	2.0
P0236.060-010-A4	M 6	10	12.0	4.6	TX-30	3.0	2.0
P0236.060-012-A4	M 6	12	12.0	4.6	TX-30	3.0	2.0
P0236.060-014-A4	M 6	14	12.0	4.6	TX-30	3.0	2.0
P0236.060-016-A4	M 6	16	12.0	4.6	TX-30	3.0	2.0
P0236.060-018-A4	M 6	18	12.0	4.6	TX-30	3.0	2.0
P0236.060-020-A4	M 6	20	12.0	4.6	TX-30	3.0	2.0
P0236.060-022-A4	M 6	22	12.0	4.6	TX-30	3.0	2.0
P0236.060-025-A4	M 6	25	12.0	4.6	TX-30	3.0	2.0
P0236.060-028-A4	M 6	28	12.0	4.6	TX-30	3.0	2.0
P0236.060-030-A4	M 6	30	12.0	4.6	TX-30	3.0	2.0
P0236.060-035-A4	M 6	35	12.0	4.6	TX-30	3.0	2.0
P0236.060-040-A4	M 6	40	12.0	4.6	TX-30	3.0	2.0
P0236.060-045-A4	M 6	45	12.0	4.6	TX-30	3.0	2.0
P0236.060-050-A4	M 6	50	12.0	4.6	TX-30	3.0	2.0
P0236.060-055-A4	M 6	55	12.0	4.6	TX-30	3.0	2.0
P0236.060-060-A4	M 6	60	12.0	4.6	TX-30	3.0	2.0
P0236.060-065-A4	M 6	65	12.0	4.6	TX-30	3.0	2.0
P0236.060-070-A4	M 6	70	12.0	4.6	TX-30	3.0	2.0
P0236.060-075-A4	M 6	75	12.0	4.6	TX-30	3.0	2.0
P0236.060-080-A4	M 6	80	12.0	4.6	TX-30	3.0	2.0
P0236.060-090-A4	M 6	90	12.0	4.6	TX-30	3.0	2.0
P0236.060-100-A4	M 6	100	12.0	4.6	TX-30	3.0	2.0
P0236.080-010-A4	M 8	10	16.0	6.0	TX-40	3.7	2.5
P0236.080-012-A4	M 8	12	16.0	6.0	TX-40	3.7	2.5
P0236.080-014-A4	M 8	14	16.0	6.0	TX-40	3.7	2.5
P0236.080-016-A4	M 8	16	16.0	6.0	TX-40	3.7	2.5
P0236.080-018-A4	M 8	18	16.0	6.0	TX-40	3.7	2.5
P0236.080-020-A4	M 8	20	16.0	6.0	TX-40	3.7	2.5
P0236.080-022-A4	M 8	22	16.0	6.0	TX-40	3.7	2.5
P0236.080-025-A4	M 8	25	16.0	6.0	TX-40	3.7	2.5
P0236.080-028-A4	M 8	28	16.0	6.0	TX-40	3.7	2.5
P0236.080-030-A4	M 8	30	16.0	6.0	TX-40	3.7	2.5
P0236.080-035-A4	M 8	35	16.0	6.0	TX-40	3.7	2.5
P0236.080-040-A4	M 8	40	16.0	6.0	TX-40	3.7	2.5
P0236.080-045-A4	M 8	45	16.0	6.0	TX-40	3.7	2.5
P0236.080-050-A4	M 8	50	16.0	6.0	TX-40	3.7	2.5
P0236.080-055-A4	M 8	55	16.0	6.0	TX-40	3.7	2.5
P0236.080-060-A4	M 8	60	16.0	6.0	TX-40	3.7	2.5
P0236.080-065-A4	M 8	65	16.0	6.0	TX-40	3.7	2.5
P0236.080-070-A4	M 8	70	16.0	6.0	TX-40	3.7	2.5
P0236.080-075-A4	M 8	75	16.0	6.0	TX-40	3.7	2.5
P0236.080-080-A4	M 8	80	16.0	6.0	TX-40	3.7	2.5
P0236.080-090-A4	M 8	90	16.0	6.0	TX-40	3.7	2.5
P0236.080-100-A4	M 8	100	16.0	6.0	TX-40	3.7	2.5

STANDARD SCREWS