

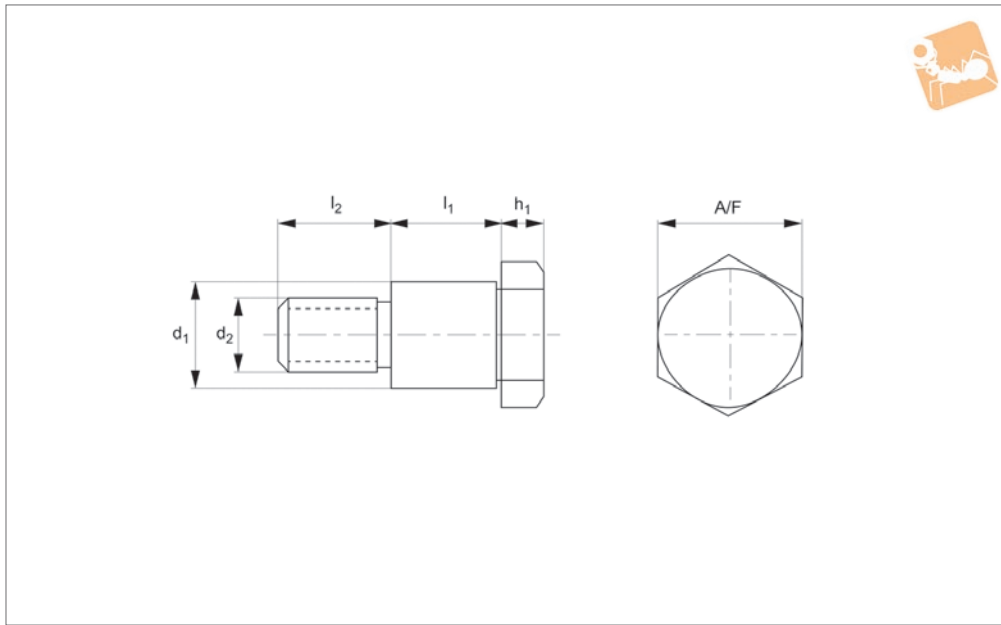

Stainless Shoulder Bolts - Hex. Head

Small sizes A2 Stainless

Shoulder Screws



P0135

SHOULDER SCREWS

Material

Stainless steel (A2, AISI 303). Tensile strength 550 N/mm².

Technical Notes

A2 stainless steel provides good resistance

to corrosion, it is soft and non-magnetic. For Ø16 (and above) stainless steel shoulder bolts see part no. P0139 and P0141.

Special lengths and diameters produced to

drawings.

Order No.	d ₁ +0.0 -0.025	l ₁ +0.0 -0.05	d ₂	l ₂	h ₁	A/F
P0135.040-004	4	4	M 3	4	2.1	5.5
P0135.040-005	4	5	M 3	4	2.1	5.5
P0135.040-006	4	6	M 3	4	2.1	5.5
P0135.040-008	4	8	M 3	4	2.1	5.5
P0135.040-010	4	10	M 3	4	2.1	5.5
P0135.050-004	5	4	M 4	5	2.9	7
P0135.050-005	5	5	M 4	5	2.9	7
P0135.050-006	5	6	M 4	5	2.9	7
P0135.050-008	5	8	M 4	5	2.9	7
P0135.050-010	5	10	M 4	5	2.9	7
P0135.050-012	5	12	M 4	5	2.9	7
P0135.050-014	5	14	M 4	5	2.9	7
P0135.050-016	5	16	M 4	5	2.9	7
P0135.050-020	5	20	M 4	5	2.9	7
P0135.050-025	5	25	M 4	5	2.9	7
P0135.050-030	5	30	M 4	5	2.9	7
P0135.060-004	6	4	M 5	6	3.6	8
P0135.060-005	6	5	M 5	6	3.6	8
P0135.060-006	6	6	M 5	6	3.6	8
P0135.060-008	6	8	M 5	6	3.6	8
P0135.060-010	6	10	M 5	6	3.6	8
P0135.060-012	6	12	M 5	6	3.6	8
P0135.060-014	6	14	M 5	6	3.6	8
P0135.060-016	6	16	M 5	6	3.6	8
P0135.060-020	6	20	M 5	6	3.6	8
P0135.060-025	6	25	M 5	6	3.6	8
P0135.060-030	6	30	M 5	6	3.6	8
P0135.080-006	8	6	M 6	11	4.1	10
P0135.080-008	8	8	M 6	11	4.1	10
P0135.080-010	8	10	M 6	11	4.1	10
P0135.080-012	8	12	M 6	11	4.1	10
P0135.080-016	8	16	M 6	11	4.1	10

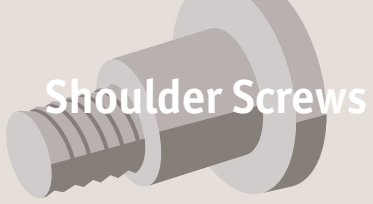

Shoulder Screws

Stainless Shoulder Bolts - Hex. Head

Small sizes A2 Stainless



SHOULDER SCREWS

Order No.	d_1 +0.0 -0.025	l_1 +0.0 -0.05	d_2	l_2	h_1	A/F
P0135.080-020	8	20	M 6	11	4.1	10
P0135.100-008	10	8	M 6	11	5.4	13
P0135.100-010	10	10	M 6	11	5.4	13
P0135.100-012	10	12	M 6	11	5.4	13
P0135.100-016	10	16	M 6	11	5.4	13
P0135.101-008	10	8	M 8	12	5.4	13
P0135.101-010	10	10	M 8	12	5.4	13
P0135.101-012	10	12	M 8	12	5.4	13
P0135.101-016	10	16	M 8	12	5.4	13
P0135.120-012	12	12	M10	16	6.6	17
P0135.120-016	12	16	M10	16	6.6	17
P0135.120-020	12	20	M10	16	6.6	17
P0135.120-025	12	25	M10	16	6.6	17



Product Overview

Shoulder Screws & Shoulder Bolts



SHOULDER SCREWS

Steel shoulder screws

These are our least expensive option. They are produced to ISO 7379 standards.

Thread sizes from Ø4 M3 to Ø24 M20. We manufacture special shoulder screws to customer drawings with a minimum batch size.



Stainless steel shoulder screws

We have three different grades of stainless steel shoulder screws:

303 series – these are our standard grade of stainless (P0130.A2). They are strong and resistant to corrosion but not to very harsh environments such as salt water.







416 series – these are made from harder stainless steel with improved shear strengths but the parts are more prone to corrosion (see part no. P0131 and P0133).

316 series – these shoulder screws (P0130.A4) are very resistant to corrosion but are considerably more expensive than other stainless versions.



Shoulder bolts

Our range of precision shoulder bolts with hexagonal heads come in both steel (grades 8.8 and 10.9) and stainless steel (303 and 316 stainless). These bolts are manufactured to DIN 609 and DIN 610. We also have shoulder bolts for construction, manufactured to DIN 7968.

	DIN 609 standard length thread	DIN 610 short length thread	DIN 7968 construction thread
Grade 8.8 steel 	 P0138.SC	 P0140.SC	 P0142
Grade 10.9 steel 	P0139	P0141	-
303 stainless steel 	P0138.A2	P0140.A2	-

ov-shoulder-screws-product-overview-a-rmh - Updated 17-02-2023



Shoulder Screw from Automation Components

Part No.		Material	Head	Corrosion resistance	Strength	Ø/thread	DIN/ISO
P0130		303 stainless steel	Hex socket	✓✓	✓	Min: Ø4/M3 Max: Ø20/M16	-
P0130.A4		316 stainless steel	Hex socket	✓✓✓	✓	Min: Ø4/M3 Max: Ø20/M16	ISO 7379
P0131		416 stainless steel	Hex socket	✓	✓✓	Min: Ø4/M3 Max: Ø12/M10	-
P0132		303 stainless steel	Slotted	✓✓	✓	Min: Ø4/M3 Max: Ø12/M10	-
P0133		416 stainless steel	Slotted	✓	✓✓	Min: Ø4/M3 Max: Ø12/M10	-
P0134		303 stainless steel	Hex socket	✓✓	✓	Min: Ø4/M3 Max: Ø8/M6	-
P0135		303 stainless steel	Hex head	✓✓	✓	Min: Ø4/M3 Max: Ø12/M10	-
P0136		Steel 12,9	Hex socket	✗	✓✓	Min: Ø4/M3 Max: Ø24/M20	ISO 7379
P0137		304 stainless steel	Hex socket	✓✓	✓	Min: Ø6/M5 Max: Ø20/M16	ISO 7379
P0138		Steel 8,8	Hex head (long thread)	✗	✓	Min: Ø9/M8 Max: Ø44/M42	DIN 610
P0139		Steel 10,9	Hex head (long thread)	✗	✓✓	Min: Ø9/M8 Max: Ø38/M36	DIN 610
P0140		Steel 8,8	Hex socket (short thread)	✗	✓✓	Min: Ø9/M8 Max: Ø44/M42	DIN 609
P0141		Steel 10,9	Hex socket (short thread)	✗	✓✓	Min: Ø9/M8 Max: Ø38/M36	DIN 609
P0142		Steel 8,8	Hex head	✗	✓✓	Min: Ø12/M12 Max: Ø27/M27	DIN 7968
P0144		303 stainless steel	Pan head	✓✓	✓✓	Min: Ø4/M3 Max: Ø10/M8	DIN 923