

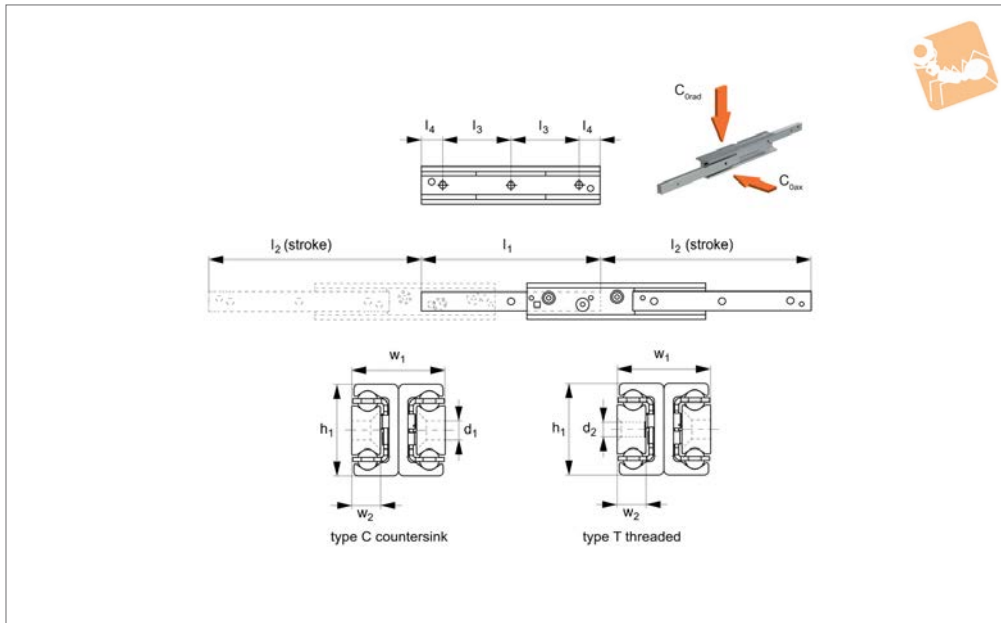

Fully Telescopic Slides

size 28

Telescopic Slides

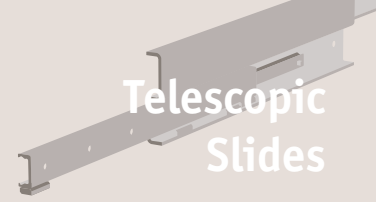

L1986.28

TELESCOPIC SLIDES

Material

Cold drawn bearing steel raceways hardened to 60 HRC. Balls - hardened steel.

Zinc coating to ISO2081 (excluding raceways). Corrosion resistant coatings available on request.

Technical Notes

These are extremely strong and rigid telescopic slides with high load capacities. C_{0rad}

is the load rating for a single telescopic slide.

Temperature range: -30°C to +170°C.

Tips

A double direction stroke can be obtained by removing the end stops screws at the end of each side of the intermediate member.

For double direction strokes, when the moving element has started the stroke in

the opposite direction it will catch the intermediate member and force it to return.

The slides have end stops, but these are not designed to stop a moving, loaded slide. External end stops should be used for this.

Only to be used for horizontal movements. Special strokes up to 130% of the closed length can be provided on request.

Order No.	h_1	l_1	l_2 stroke	l_3	l_4	w_1	w_2	For screws d_1 & d_2	No. of holes	Hole type	Load (per rail) N max.	C_{0ax}	Load (per rail) N max.	C_{0rad}	Weight kg
L1986.28C-0130	28	130	148	80	25	26	7,5	5,5	2	C'sunk	164		235		0,52
L1986.28C-0210	28	210	232	80	25	26	7,5	5,5	3	C'sunk	302		432		0,84
L1986.28C-0290	28	290	296	80	25	26	7,5	5,5	4	C'sunk	537		767		1,16
L1986.28C-0370	28	370	380	80	25	26	7,5	5,5	5	C'sunk	471		968		1,48
L1986.28C-0450	28	450	464	80	25	26	7,5	5,5	6	C'sunk	385		1169		1,80
L1986.28C-0530	28	530	548	80	25	26	7,5	5,5	7	C'sunk	325		1107		2,12
L1986.28C-0610	28	610	633	80	25	26	7,5	5,5	8	C'sunk	280		964		2,44
L1986.28C-0690	28	690	717	80	25	26	7,5	5,5	9	C'sunk	247		849		2,76
L1986.28C-0770	28	770	801	80	25	26	7,5	5,5	10	C'sunk	221		758		3,08
L1986.28C-0850	28	850	866	80	25	26	7,5	5,5	11	C'sunk	208		713		3,40
L1986.28C-0930	28	930	950	80	25	26	7,5	5,5	12	C'sunk	189		646		3,72
L1986.28C-1010	28	1010	1034	80	25	26	7,5	5,5	13	C'sunk	174		592		4,04
L1986.28C-1090	28	1090	1118	80	25	26	7,5	5,5	14	C'sunk	160		547		4,36
L1986.28C-1170	28	1170	1202	80	25	26	7,5	5,5	15	C'sunk	149		508		4,68
L1986.28T-0130	28	130	148	80	25	26	7,5	5,5	2	Thread	164		235		0,52
L1986.28T-0210	28	210	232	80	25	26	7,5	5,5	3	Thread	302		432		0,84
L1986.28T-0290	28	290	296	80	25	26	7,5	5,5	4	Thread	537		767		1,16
L1986.28T-0370	28	370	380	80	25	26	7,5	5,5	5	Thread	471		968		1,48
L1986.28T-0450	28	450	464	80	25	26	7,5	5,5	6	Thread	385		1169		1,80
L1986.28T-0530	28	530	548	80	25	26	7,5	5,5	7	Thread	325		1107		2,12
L1986.28T-0610	28	610	633	80	25	26	7,5	5,5	8	Thread	280		964		2,44
L1986.28T-0690	28	690	717	80	25	26	7,5	5,5	9	Thread	247		849		2,76
L1986.28T-0770	28	770	801	80	25	26	7,5	5,5	10	Thread	221		758		3,08
L1986.28T-0850	28	850	866	80	25	26	7,5	5,5	11	Thread	208		713		3,40
L1986.28T-0930	28	930	950	80	25	26	7,5	5,5	12	Thread	189		646		3,72



Order No.	h_1	l_1	l_2 stroke	l_3	l_4	w_1	w_2	For screws d_1 & d_2	No. of holes	Hole type	Load (per rail) $C_{0_{ax}}$ N max.	Load (per rail) $C_{0_{rad}}$ N max.	Weight kg
L1986.28T-1010	28	1010	1034	80	25	26	7,5	5,5	13	Thread	174	592	4,04
L1986.28T-1090	28	1090	1118	80	25	26	7,5	5,5	14	Thread	160	547	4,36
L1986.28T-1170	28	1170	1202	80	25	26	7,5	5,5	15	Thread	149	508	4,68

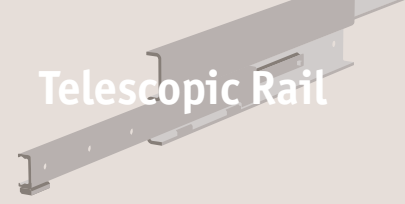

If you are looking for heavy duty, quality telescopic rails for industrial or commercial applications then these are the rails for you!

The best heavy duty telescopic slides on the market

These are unique rails that are not made from pressed steel but from cold-drawn steel section. The rails can take high loads, with very long strokes, with repeated use, low deflection and minimal play.

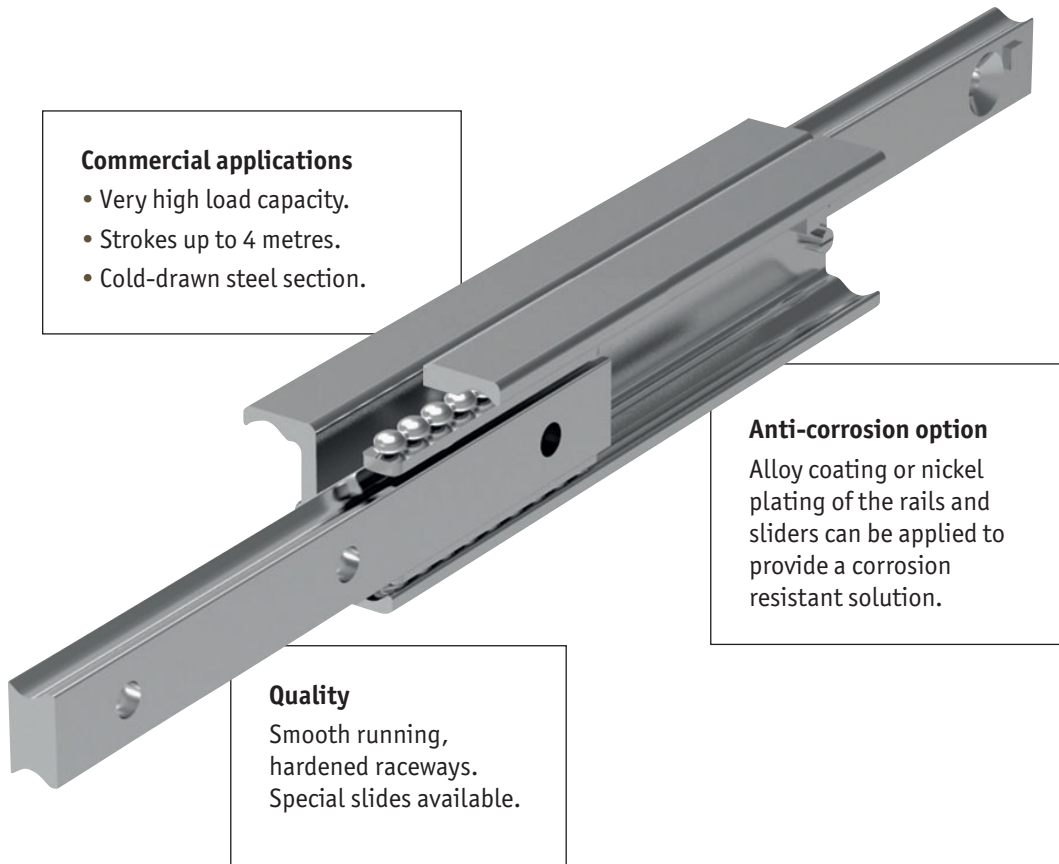

Commercial applications

- Very high load capacity.
- Strokes up to 4 metres.
- Cold-drawn steel section.

Anti-corrosion option

Alloy coating or nickel plating of the rails and sliders can be applied to provide a corrosion resistant solution.

Quality

Smooth running, hardened raceways. Special slides available.



Partial Stroke (~60%)

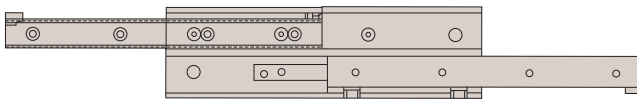

Full Stroke (~100%)

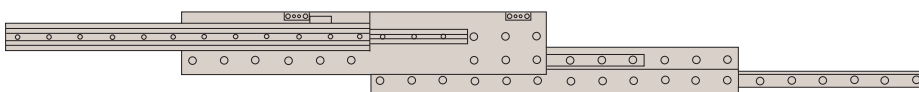

Over-extension (150%)

Rail types

Our range of telescopic rails covers partial, full stroke and over-extension.

For more information refer to our product specifications pages or call our technical department.



Specifications

- Generally all our telescopic rails have induction hardened raceways.
- Cold drawn roller bearing steel.
- Maximum operating speed 0,8 m/s.
- Temperature range (mainly -30°C to +170°C).
- Electrolytic galvanised to ISO 2081, other anti-corrosion finishes on request.
- High load ratings with low deflection characteristics.
- Minimum play (even at maximum load ratings).
- Smooth, free running movement.
- Long strokes and heavy load ratings.
- Can be used in horizontal applications only (due to the use of a ball cage), with the exception of part number L1985 which uses roller bearings.
- Light duty “cage stops” are included on the telescopic rails to prevent damage to the ball cage. External end stops must be designed into your application (to protect the rails from high forces and possible damage on opening and closing).
- For telescopic rails with an “upper” and “lower” rail, the moving rail should be the lower one. Using the upper rail as the moving element effects the smooth running and the load capacity of the telescopic sliders.
- All load capacity figures are given for a single rail, and based on continuous use.
- Fix to structures using screws of strength class 10,9.
- Anti-corrosion option. We have a highly effective anti-corrosive coating option, and we utilise stainless steel ball bearings in this version.

Applications



Special purpose & packaging machines

Precision positioning systems
handling units
robotic systems • cutting machines



Seating

Sliding seats
disability ramps
seat extensions



Safety guarding

Extending protective systems
sliding gates
automatic pick & place



Logistics solutions

Container extensions
heavy duty extending systems
sliding doors



Disability vehicles

Sliding seats
extension ramps



Transport (naval)

Sliding hatches
pull-out storage



Transport (rail)

Seat adjustment
sliding doors
battery removal units



Transport (automotive)

Ambulance sliding systems
fire fighting vehicles
sliding panels



Transport (military)

Sliding seats
protective hatches
stretcher extensions

L1989 - these are full extension slides made from 316L stainless steel. For use in applications where corrosion may be a problem.

Standard extension	100%
Special extension range	No
Single & double direction?	No
Number of rail sizes	1
Maximum extension (at 100%)	1120 mm
Maximum load (per rail)	35 Kg



Extended stroke telescopic rails

L1997 - these are extended stroke (150%), heavy duty telescopic rails, with high load capacity and stiffness.

Standard extension	150%
Special extension range	On request
Single & double direction?	No
Number of rail sizes	1
Maximum extension (at 150%)	3030 mm
Maximum load (per rail)	240 Kg



L1998 - these are extended stroke (150%), heavy duty telescopic rails. They have a solid steel intermediate element. They are our heaviest duty extended stroke units.

Standard extension	150%
Special extension range	On request
Single & double direction?	No
Number of rail sizes	1
Maximum extension (at 150%)	3020 mm
Maximum load (per rail)	480 Kg

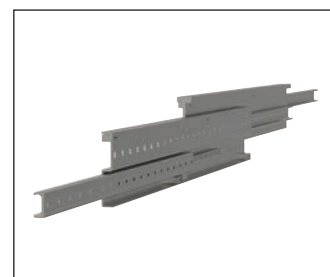



Service life

The service life is defined as the time span between commissioning and the first fatigue or wear indications on the raceway. The service life of a telescopic rail is dependent on several factors, such as the effective load, the installation precision, occurring shocks and vibrations, the operating temperature, the ambient conditions and the lubrication.

Calculation of the service life is based exclusively on the loaded rows of balls.

In practice, the decommissioning of the bearing, due to its destruction or extreme wear of a component, represents the end of service life.

This is taken into account by an application coefficient (f_i), so the service life consists of:

$$L_{Km} = 100 \cdot \left(\frac{\delta}{W} \cdot \frac{1}{f_i} \right)^3$$

L = calculated service life in Km

δ = load capacity factor in N (see tables on following pages)

W = equivalent load in N

f_i = application coefficient

Application coefficient f_i

Operating conditions	Safety factor (f_i)
Neither shocks or vibrations, smooth and low-frequency direction change, clean environment	1,3 - 1,8
Light vibrations and average direction change	1,8 - 2,3
Shocks and vibrations, high-frequency direction change, very dirty environment	2,3 - 3,5

If the external load, P , is the same as the dynamic load capacity, C_{0rad} (which of course must never be exceeded), the service life at ideal operating conditions ($f_i = 1$) is 100Km.

For a single load P , the following applies: $W = P$.

If several external loads occur simultaneously, the equivalent load is calculated as follows:

$$W = P_{rad} + \left(\frac{P_{ax}}{C_{0ax}} + \frac{M_1}{M_x} + \frac{M_2}{M_y} + \frac{M_3}{M_z} \right) \cdot C_{0rad}$$