



50Ø Shaft Support Rails

complete stainless and aluminium support



Linear Shaft Supports

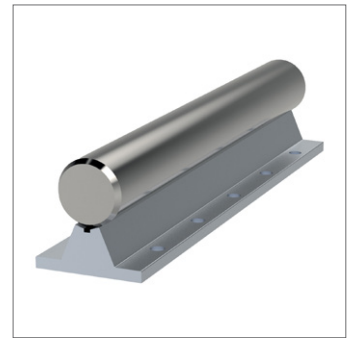
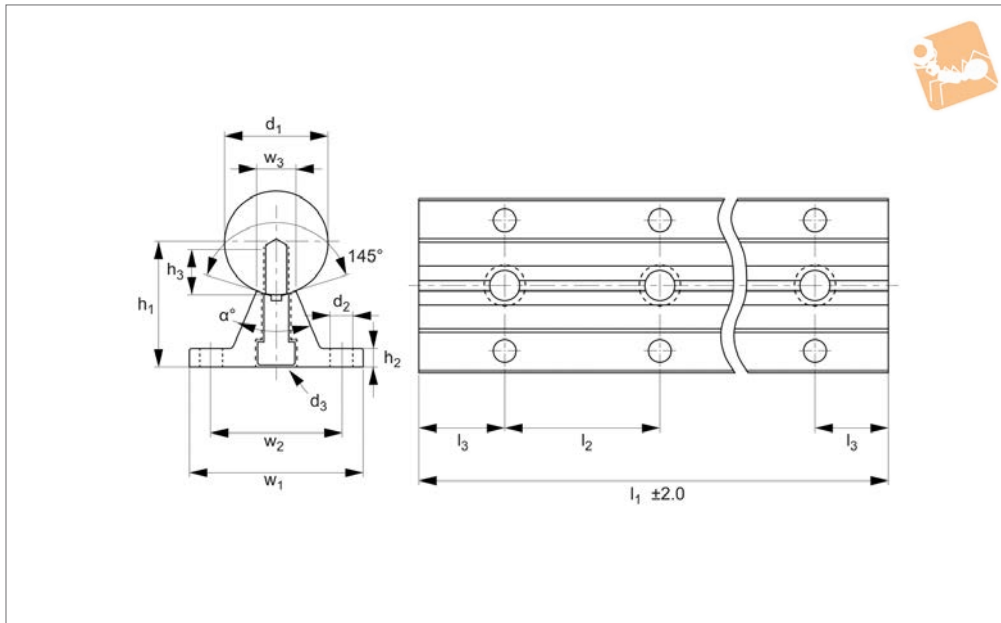

L1781.50

LINEAR SHAFT SUPPORTS

Material

Hardened and ground stainless steel shaft (440C), aluminium alloy support rail.
Surface hardness of shaft 60-65 HRC.

Technical Notes

For open linear bushings, ensures a very rigid and stiff system.

The shaft is pre-mounted to the shaft support rail.

Standard lengths are shown which allow the distance to the first and last hole to be equal (ie $l_2/2$). Different holes pitches available on request.

Straightness: $\pm 0.1\text{mm/metre}$.

Tips

For linear carriages see part no. L1755 (flanged) or L1752 (unflanged).
Stainless steel carriages also available, see part no. L1756 (flanged) or L1753 (unflanged).

Order No.	d_1 tol. h6	d_2	d_3	l_1	l_2	l_3	w_1	w_2	w_3	h_1 ± 0.02	h_2	h_3	α °
L1781.50-0600	50	11	M12x45	600	300	150	84	63	19	60	9	21	46
L1781.50-0900	50	11	M12x45	900	300	150	84	63	19	60	9	21	46
L1781.50-1200	50	11	M12x45	1200	300	150	84	63	19	60	9	21	46
L1781.50-1500	50	11	M12x45	1500	300	150	84	63	19	60	9	21	46
L1781.50-1800	50	11	M12x45	1800	300	150	84	63	19	60	9	21	46
L1781.50-2100	50	11	M12x45	2100	300	150	84	63	19	60	9	21	46
L1781.50-2400	50	11	M12x45	2400	300	150	84	63	19	60	9	21	46
L1781.50-2700	50	11	M12x45	2700	300	150	84	63	19	60	9	21	46
L1781.50-3000	50	11	M12x45	3000	300	150	84	63	19	60	9	21	46
L1781.50-3300	50	11	M12x45	3300	300	150	84	63	19	60	9	21	46
L1781.50-3600	50	11	M12x45	3600	300	150	84	63	19	60	9	21	46
L1781.50-3900	50	11	M12x45	3900	300	150	84	63	19	60	9	21	46
L1781.50-4200	50	11	M12x45	4200	300	150	84	63	19	60	9	21	46
L1781.50-4500	50	11	M12x45	4500	300	150	84	63	19	60	9	21	46
L1781.50-4800	50	11	M12x45	4800	300	150	84	63	19	60	9	21	46
L1781.50-5100	50	11	M12x45	5100	300	150	84	63	19	60	9	21	46
L1781.50-5400	50	11	M12x45	5400	300	150	84	63	19	60	9	21	46
L1781.50-5700	50	11	M12x45	5700	300	150	84	63	19	60	9	21	46
L1781.50-6000	50	11	M12x45	6000	300	150	84	63	19	60	9	21	46

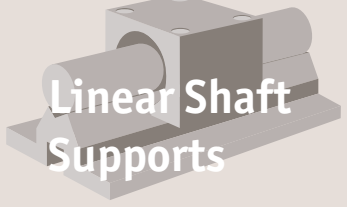

Linear Shaft Supports

50Ø Shaft Support Rails
complete stainless and aluminium support



LINEAR SHAFT SUPPORTS

